

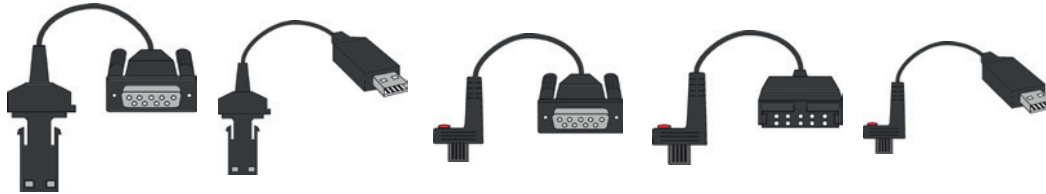

1998 / 0996 / 1997 Data cable



0996 701

0996 705

1997 501

1998 501

1998 720

Model

- Length 2 m
- For use with MarCom Professional software to transfer the measured results to PC, laptop or workstation

Model	Description	Order no.	List price EUR
0996 701	Cable Opto for RS232	0996 701	77.00
0996 705	Cable Opto for USB	0996 705	147.00
1997 501	Cable DataVariable for RS232	1997 501	50.00
1998 501	Cable DataVariable for Digimatic	1998 501	64.00
1998 720	Cable DataVariable for USB	1998 720	72.00

0145 Measuring tool set >>Extensions<<

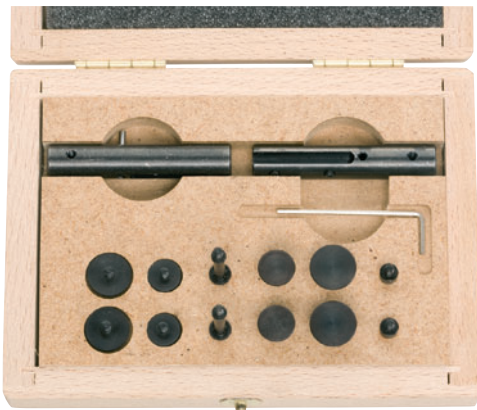

Model

- Pairs of measuring inserts, disc dia. 6 / 10 / 12.5 mm
- Pair of measuring inserts with 60° cone, dia. 9 / 12.5 mm
- Pair of measuring inserts with cylindrical surfaces 1.5 mm
- Insert holder, right / left with thread M 2.5
- Allen wrench SW 1.2 mm
- For digital pocket calipers with max. jaw thickness of 3.5 mm

Delivery

- Wooden box

Model	Description	Order no.	List price EUR
0145 110	Measuring tool set, 14 pieces	0145 110	171.00



Measure distances between bore holes

Measure grooves

Measure distances

Measure distances between bore holes

Measure grooves



HELIOS · PREISSER

1326 Universal pocket caliper „Pocket Talent“



Incl. setting standard

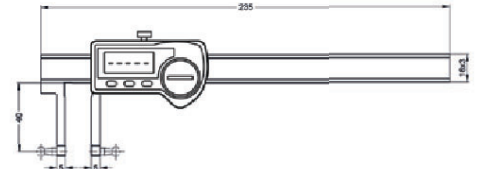

Model

- Stainless steel
- Protection class IP67
- Factory standard
- LCD display 7.5 mm
- Locking screw
- For internal and external measurements
- Individually adaptable on problematic tasks through measuring inserts with thread M 2.5

Functions

- ON / OFF
- **Quick-Start**
- **Quick-Lock** (key lock)
- Set to zero at any point
- mm / inch switching
- PRESET-Function (setting a numerical value)
- Variable data output RS 232 + Digimatic + USB

Delivery

- Wooden box
- Measuring inserts No. 0710161* and 0710177*
Planar surface Ø 4.8 mm /
Ball inserts Ø 5.0 mm
- Setting standard

Models with measuring range 300 and 500 mm on page 56

Measuring range	Measuring range		Jaw length	Reading		Order no.	List price
	mm	inch		mm	mm		
0 - 150	0 - 6	40	0.01	.0005	1326 932	359.00	

Our all-round talent can be combined with all common types of measuring inserts for indicators with a standard M 2.5 thread. This way, the Pocket Talent offers you various solutions for numerous measurement applications.

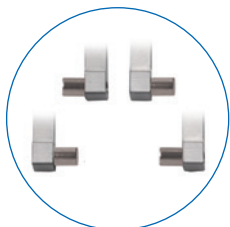

0710161*

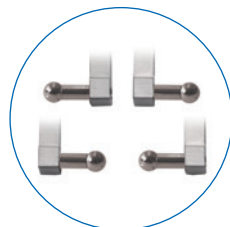

0710177*

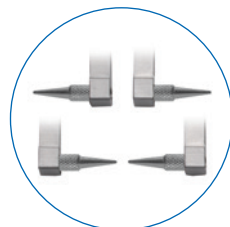

0710166

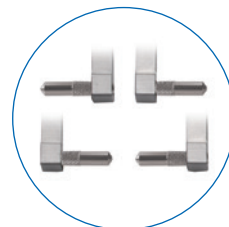

0710167

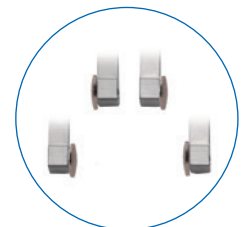

0710163



1998720



1998501



1997501



Product video

Accessories

Accessories	Order no.	List price
		EUR
Battery, 3V-Lithium, CR 2032	0220 704	3.90
Measuring inserts M 2.5	0710 161	3.60
Measuring inserts M 2.5	0710 163	5.40
Measuring inserts M 2.5	0710 166	4.90
Measuring inserts M 2.5	0710 167	3.40
Measuring inserts M 2.5	0710 177	6.80
Setting standard for Pocket Talent	1326 990	39.00
Data cable DATA VARIABLE to RS232	1997 501	50.00
Data cable DATA VARIABLE to digimatic	1998 501	64.00
Data cable DATA VARIABLE to USB	1998 720	72.00



1326 DIGI-MET® Pocket calipers for specific measuring tasks

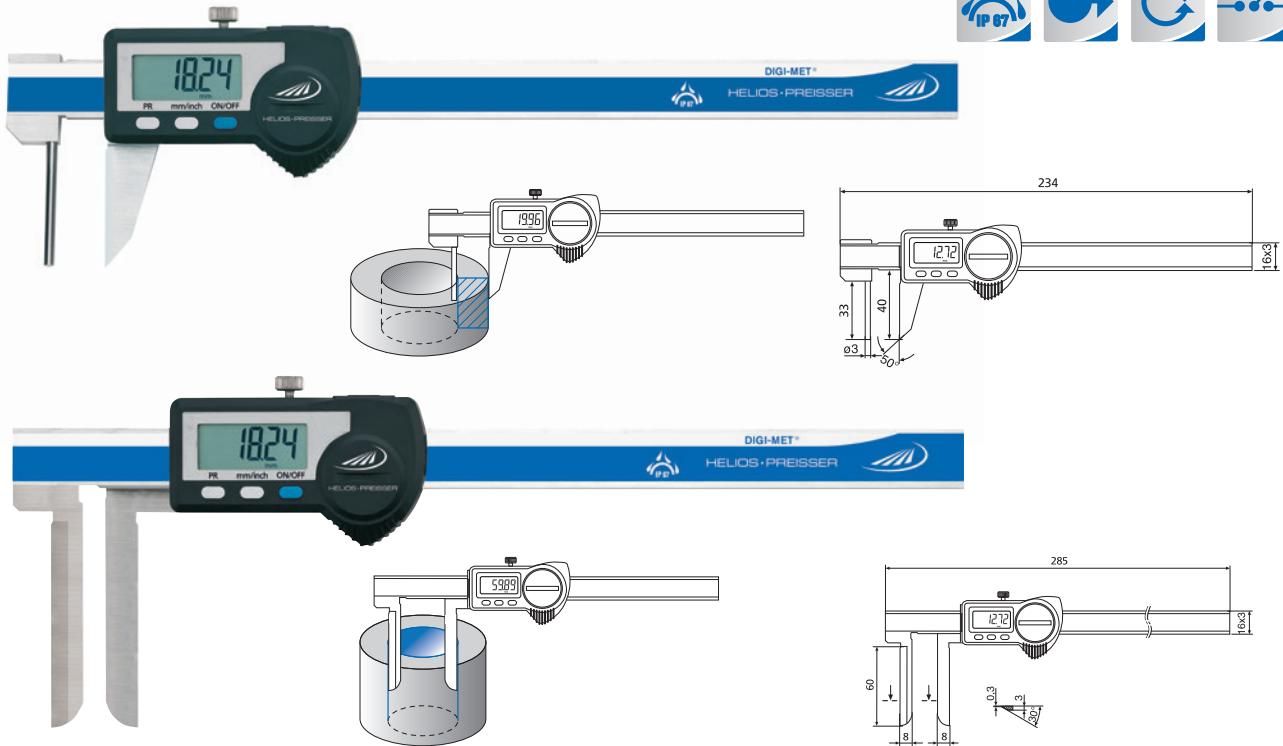

Model

- Protection class IP67
- Stainless steel
- LCD display 7.5 mm
- Factory standard
- Measuring system is insensitive to cooling agents and dust

- Housing and operating keys have an excellent chemical resistance
- Inside cross points
- Locking screw

Functions

- ON / OFF
- Quick-Start
- Quick-Lock (key lock)
- Set to zero at any point
- mm / inch switching
- PRESET-Function (setting a numerical value)
- Variable data output RS 232 + Digimatic + USB

Delivery

- Wooden case

Icon	Measuring range		Jaw length		Reading		Order no.	List price EUR
	mm	inch	mm	inch	mm	inch		
	0 - 150	0 - 6	40	1.6	0.01	.0005	1326 918	503.00
	10 - 200	0.4 - 8	60	2.4	0.01	.0005	1326 930	653.00

Accessories



1998720 1997501 1998501

Accessories	Order no.	List price EUR
Battery, 3V-Lithium, CR 2032	0220 704	3.90
Data cable DATA VARIABLE to RS232	1997 501	50.00
Data cable DATA VARIABLE to digimatic	1998 501	64.00
Data cable DATA VARIABLE to USB	1998 720	72.00



HELIOS · PREISSER

1326 DIGI-MET® Pocket calipers for specific measuring tasks

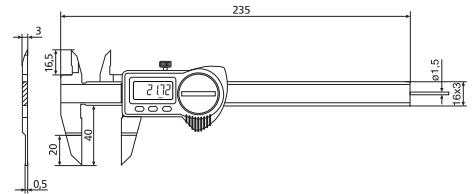
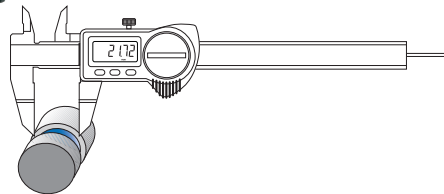
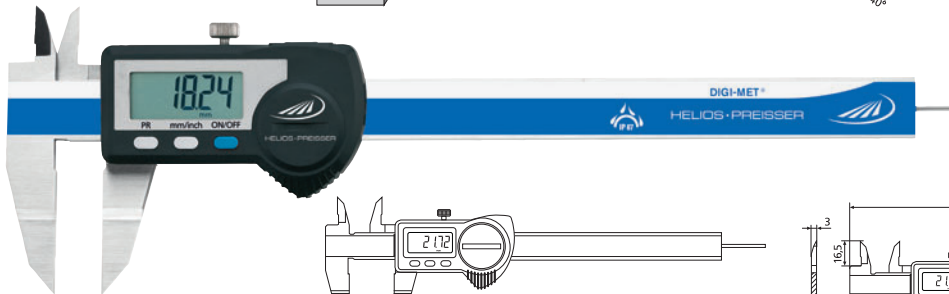
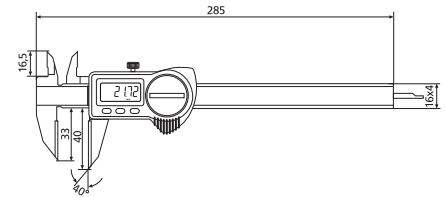
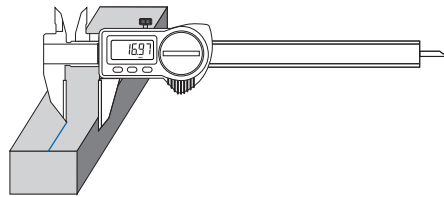
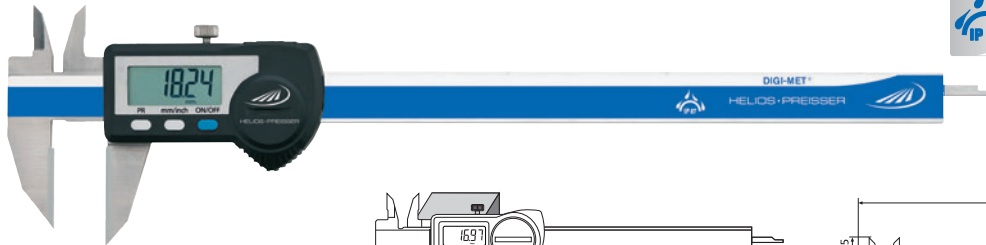

Model

- Protection class IP67
- Stainless steel
- LCD display 7,5 mm
- Factory standard
- Measuring system is insensitive to cooling agents and dust

- Housing and operating keys have an excellent chemical resistance
- Inside cross points
- Locking screw

Functions

- ON / OFF
- Quick-Start
- Quick-Lock (key lock)
- Set to zero at any point
- mm / inch switching
- PRESET-Function (setting a numerical value)
- Variable data output RS 232 + Digimatic + USB

Delivery

- Wooden case

Icon	Measuring range		Jaw length		Reading		Depth gauge	Order no.	List price EUR
	mm	inch	mm	inch	mm	inch			
Scribing caliper with carbide-tipped outer measuring surfaces									
	0 - 200	0 - 8	33	1.3	0.01	.0005	rectangular	1326 912	320.00
With flat measuring surfaces e.g. for outer recesses									
	0 - 150	0 - 6	40	1.6	0.01	.0005	round 1.5	1326 920	545.00

Accessories



1998720 1997501 1998501

	Order no.	List price EUR
Battery, 3V-Lithium, CR 2032	0220 704	3.90
Data cable DATA VARIABLE to RS232	1997 501	50.00
Data cable DATA VARIABLE to digimatic	1998 501	64.00
Data cable DATA VARIABLE to USB	1998 720	72.00



1326 DIGI-MET® Pocket calipers for specific measuring tasks

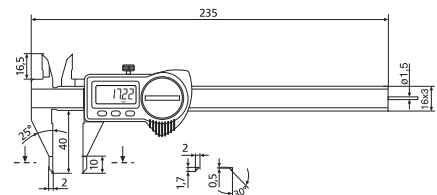
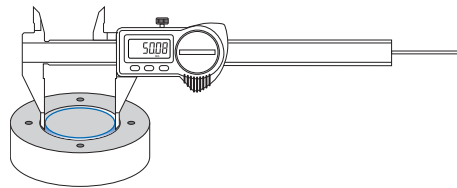
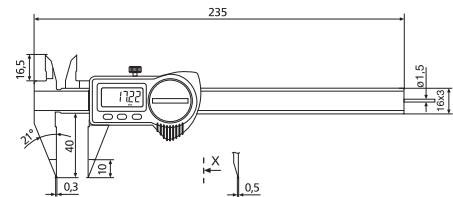
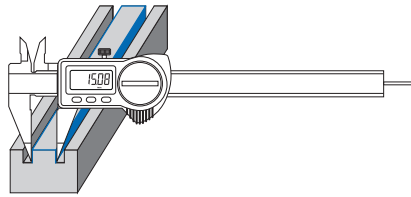

Model

- Protection class IP67
- Stainless steel
- LCD display 7.5 mm
- Factory standard
- Measuring system is insensitive to cooling agents and dust

- Housing and operating keys have an excellent chemical resistance
- Inside cross points
- Locking screw

Functions

- ON / OFF
- Quick-Start
- Quick-Lock (key lock)
- Set to zero at any point
- mm / inch switching
- PRESET-Function (setting a numerical value)
- Variable data output RS 232 + Digimatic + USB

Delivery

- Wooden case

Measuring range	Jaw length		Reading		Order no.	List price EUR
	mm	inch	mm	inch		
With pointed jaws						
0 - 150	0 - 6	40	1.6	0.01	.0005	1326 916 396.00
With fine measuring tips						
0 - 150	0 - 6	40	1.6	0.01	.0005	1326 922 447.00



Accessories

	Order no.	List price EUR
Battery, 3V-Lithium, CR 2032	0220 704	3.90
Data cable DATA VARIABLE to RS232	1997 501	50.00
Data cable DATA VARIABLE to digimatic	1998 501	64.00
Data cable DATA VARIABLE to USB	1998 720	72.00



HELIOS · PREISSER

1326 DIGI-MET® Pocket calipers for specific measuring tasks



1

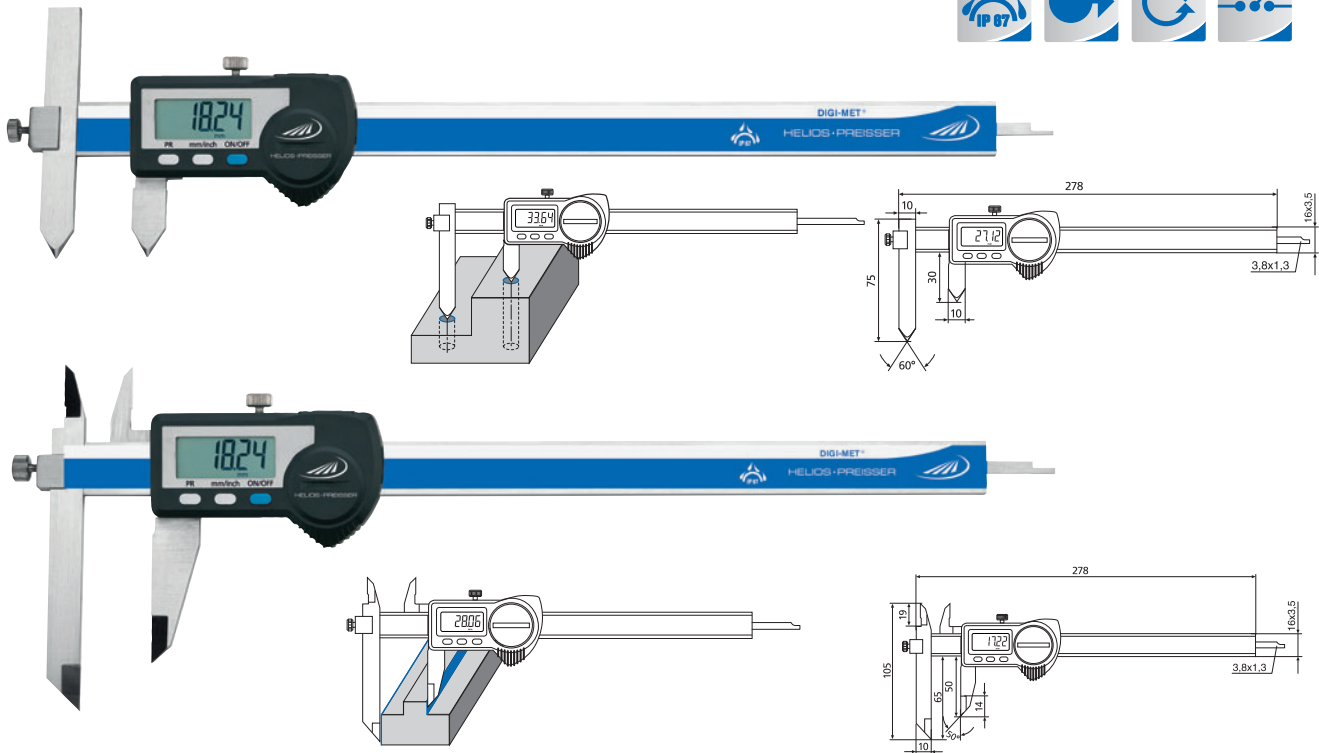

Model

- Protection class IP67
- Stainless steel
- LCD display 7.5 mm
- Factory standard
- Measuring system is insensitive to cooling agents and dust

- Housing and operating keys have an excellent chemical resistance
- Inside cross points
- Locking screw

Functions

- ON / OFF
- Quick-Start**
- Quick-Lock** (key lock)
- Set to zero at any point
- mm / inch switching
- PRESET-Function (setting a numerical value)
- Variable data output RS 232 + Digimatic + USB

Delivery

- Wooden case

Icon	Measuring range		Jaw length		Reading		Order no.	List price EUR
	mm	inch	mm	inch	mm	inch		
Moving jaws for measuring the distance between bores								
	10 - 210	0.4 - 8.3	75	3.0	0.01	.0005	1326 924	443.00
Moving jaws + cross tips								
	0 - 200	0 - 8	65	2.5	0.01	.0005	1326 928	476.00



1998720

1998501

1997501

Accessories

	Order no.	List price EUR
Battery, 3V-Lithium, CR 2032	0220 704	3.90
Data cable DATA VARIABLE to RS232	1997 501	50.00
Data cable DATA VARIABLE to digimatic	1998 501	64.00
Data cable DATA VARIABLE to USB	1998 720	72.00



1326 DIGI-MET® Pocket calipers for specific measuring tasks

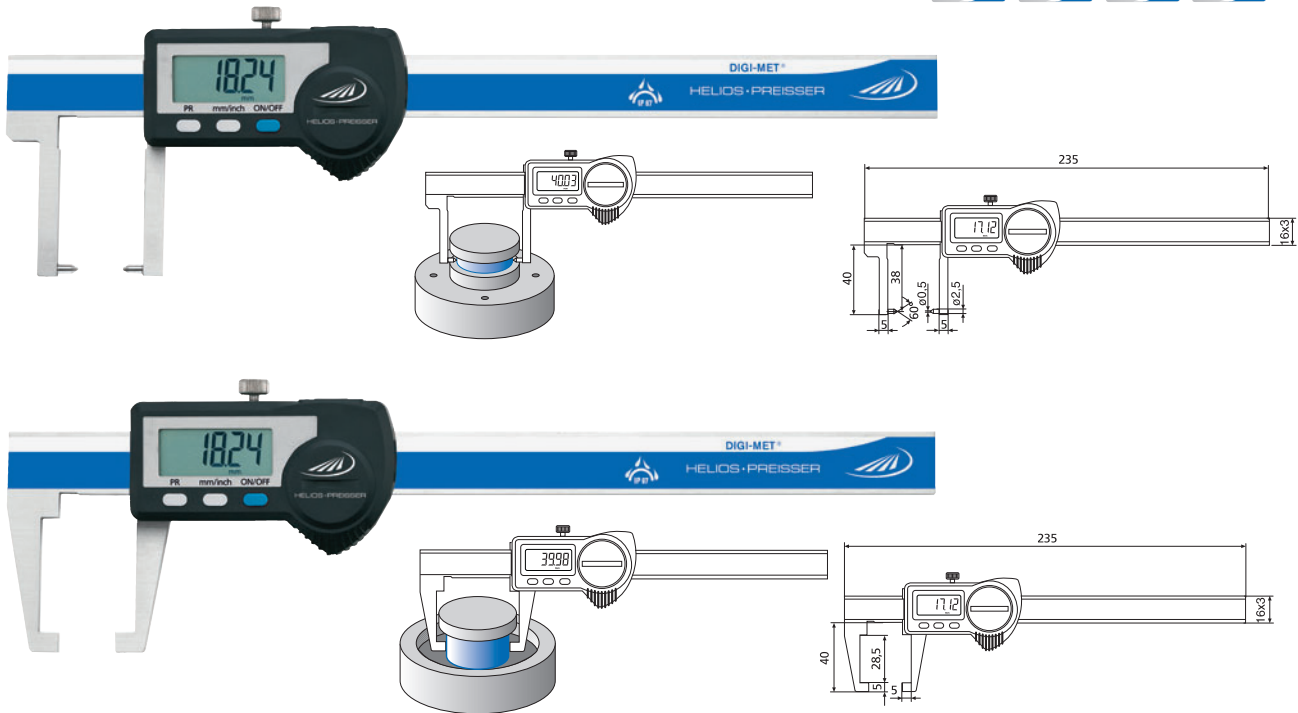

Model

- Protection class IP67
- Stainless steel
- LCD display 7.5 mm
- Factory standard
- Measuring system is insensitive to cooling agents and dust

- Housing and operating keys have an excellent chemical resistance
- Inside cross points
- Locking screw

Functions

- ON / OFF
- Quick-Start
- Quick-Lock (key lock)
- Set to zero at any point
- mm / inch switching
- PRESET-Function (setting a numerical value)
- Variable data output RS 232 + Digimatic + USB

Delivery

- Wooden case

Measuring range	Measuring range		Jaw length		Reading		Order no.	List price EUR
	mm	inch	mm	inch	mm	inch		
Measuring tips angled inwards								
0 - 150	0 - 6	40	1.6	0.01	.0005	1326 904	573.00	
Measuring jaws angled inwards								
0 - 150	0 - 6	40	1.6	0.01	.0005	1326 908	489.00	

Accessories



1998720

1997501

1998501

Battery, 3V-Lithium, CR 2032

data cable DATA VARIABLE to RS232

data cable DATA VARIABLE to digimatic

data cable DATA VARIABLE to USB

Order no.

0220 704

1997 501

1998 501

1998 720

List price
EUR

3.90

50.00

64.00

72.00



HELIOS · PREISSER

1326 DIGI-MET® Pocket calipers for specific measuring tasks

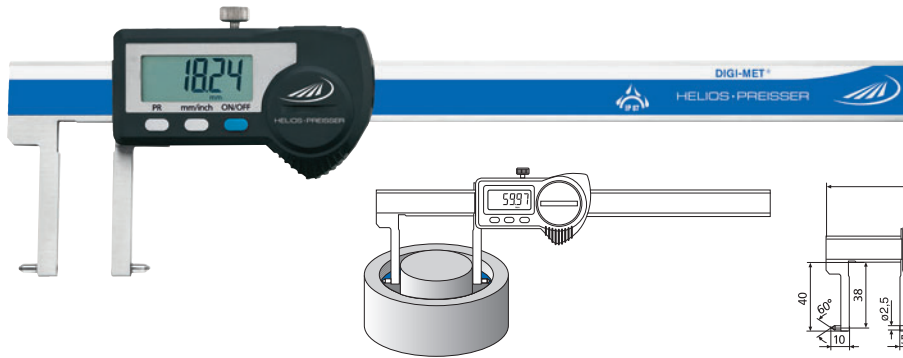

Model

- Protection class IP67
- Stainless steel
- LCD display 7.5 mm
- Factory standard
- Measuring system is insensitive to cooling agents and dust

- Housing and operating keys have an excellent chemical resistance
- Inside cross points
- Locking screw

Functions

- ON / OFF
- Quick-Start
- Quick-Lock (key lock)
- Set to zero at any point
- mm / inch switching
- PRESET-Function (setting a numerical value)
- Variable data output RS 232 + Digimatic + USB

Delivery

- Wooden case

Measuring range	Measuring range		Jaw length		Reading		Order no.	List price EUR
	mm	inch	mm	inch	mm	inch		
Measuring tips angled outwards								
20.5 - 170	0.8 - 6.7	40	1.6	0.01	.0005	1326 906	568.00	
Measuring jaws angled outwards								
10.5 - 160	0.4 - 6.3	40	1.6	0.01	.0005	1326 910	562.00	

Accessories



	Order no.	List price EUR
Battery, 3V-Lithium, CR 2032	0220 704	3.90
Data cable DATA VARIABLE to RS232	1997 501	50.00
Data cable DATA VARIABLE to digimatic	1998 501	64.00
Data cable DATA VARIABLE to USB	1998 720	72.00



HELIOS · PREISSER

1351 DIGI-MET® Caliper with cross points



1

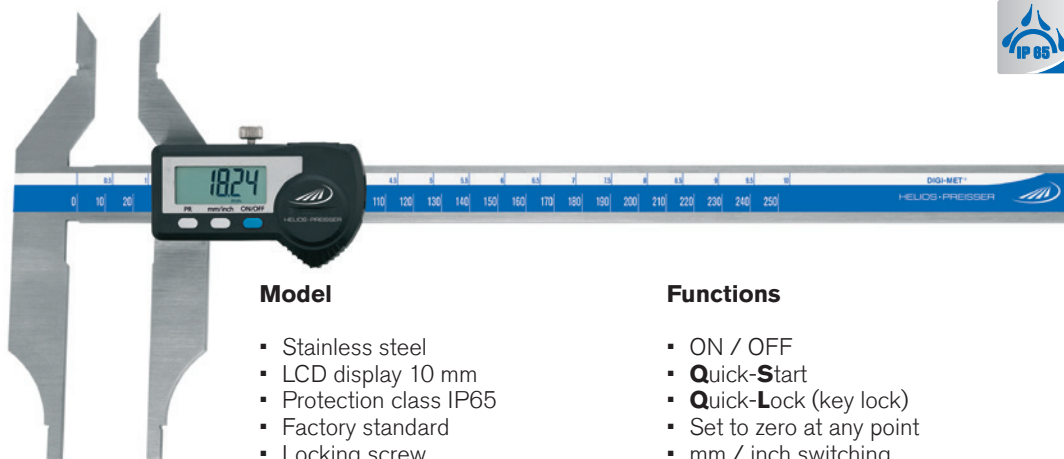

Model

- Stainless steel
- LCD display 10 mm
- Protection class IP65
- Factory standard
- Locking screw
- Inside cross points 55 mm

Functions

- ON / OFF
- **Quick-Start**
- **Quick-Lock** (key lock)
- Set to zero at any point
- mm / inch switching
- PRESET-Function (setting a numerical value)
- Variable data output RS 232 + Digimatic + USB

Delivery

- Wooden case

Measuring range	Jaw length		Reading		Error limit	Order no.	List price	
	mm	inch	mm	inch				mm
0 - 250	0 - 10	80	3.2	0.01	.0005	0.03	1351 920	499.00



1354 DIGI-MET® Caliper with gripper points

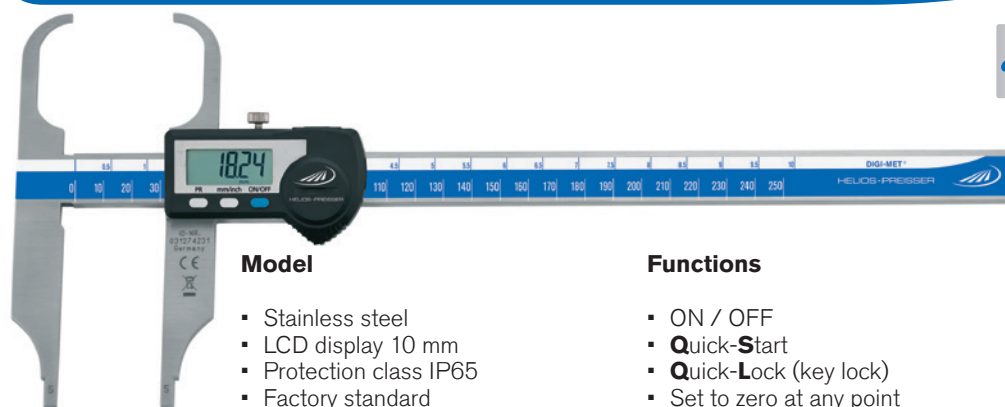

Model

- Stainless steel
- LCD display 10 mm
- Protection class IP65
- Factory standard
- Locking screw
- Gripper points 55 mm

Functions

- ON / OFF
- **Quick-Start**
- **Quick-Lock** (key lock)
- Set to zero at any point
- mm / inch switching
- Hold
- PRESET-Function (setting a numerical value)

- Variable data output RS 232 + Digimatic + USB

Delivery

- Wooden case

Measuring range	Jaw length		Reading		Error limit	Order no.	List price	
	mm	inch	mm	inch				mm
0 - 250	0 - 10	75	3.0	0.01	.0005	0.03	1354 520	590.00



1998720 1997501 1998501

Accessories

	Order no.	List price
Battery, 3V-Lithium, CR 2032	0220 704	3.90
Data cable DATA VARIABLE to RS232	1997 501	50.00
Data cable DATA VARIABLE to digimatic	1998 501	64.00
Data cable DATA VARIABLE to USB	1998 720	72.00

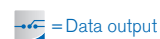



1348 DIGI-MET® Universal calipers

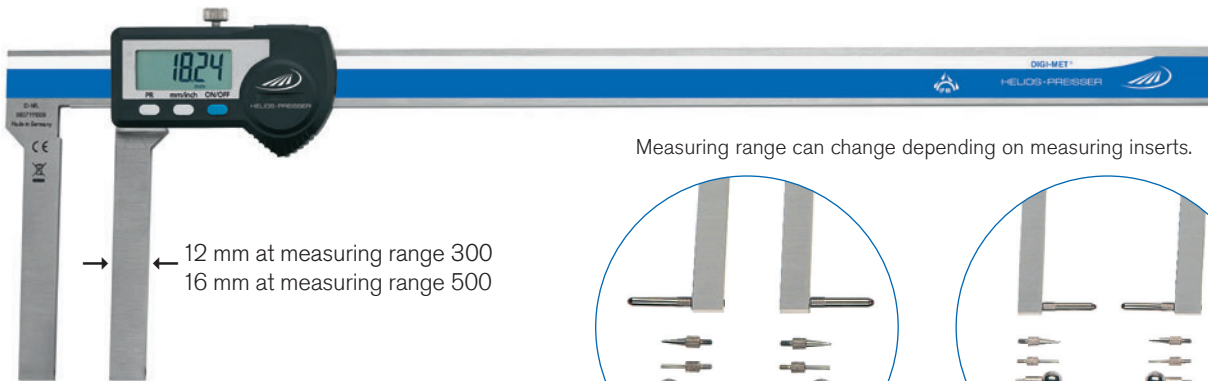

12 mm at measuring range 300
16 mm at measuring range 500

Measuring range can change depending on measuring inserts.

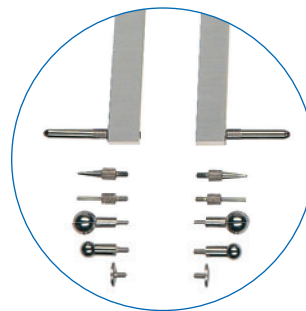

for internal measurements

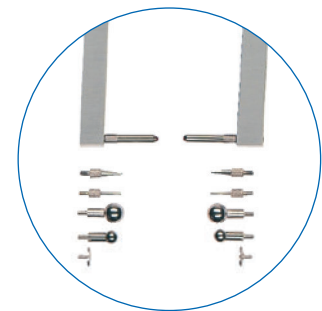

for external measurements

Model

- Stainless steel
- Factory standard
- Protection class IP65
- LCD display 10 or 12.5 mm
- Locking screw
- For internal and external measurements
- Individually adaptable on problematic tasks through measuring inserts with thread M 2.5

Functions

- ON / OFF
- **Quick-Start**
- **Quick-Lock** (key lock)
- Set to zero at any point
- mm / inch switching
- PRESET-Function (setting a numerical value)
- Variable data output RS 232 + Digimatic + USB

Delivery

- Wooden box
- Without measuring inserts (correct measuring inserts with thread M 2.5 see pages 137 - 140)

Model „Pocket Talent“ with measuring range 150 mm on page 29

✕	Measuring range		Jaw length		Reading		Error limit	Order no.	List price
	mm	inch	mm	inch	mm	inch	mm		EUR
	0 - 300	0 - 12	90	3.5	0.01	.0005	0.06	1348 722	607.00
	0 - 500	0 - 20	100	4.0	0.01	.0005	0.06	1348 728	778.00



1998720

1998501

1997501

Accessories

- Battery, 3V-Lithium, CR 2032
- Data cable DATA VARIABLE to RS232
- Data cable DATA VARIABLE to digimatic
- Data cable DATA VARIABLE to USB

Order no.

- 0220 704
- 1997 501
- 1998 501
- 1998 720

List price EUR

- 3.90
- 50.00
- 64.00
- 72.00



1320 DIGI-MET® Pocket caliper with 40 mm inside cross points



DIN
862



Model

- Inductive measuring system, resistant to damp and sweat
- Stainless steel
- LCD display 7.5 mm
- DIN 862
- Locking screw
- Inside cross points
- Four way measurement

Functions

- ON / OFF
- **Quick-Start**
- **Quick-Lock** (key lock)
- Set to zero at any point
- mm / inch switching
- Variable data output
RS 232 + Digimatic + USB

Delivery

- Plastic case

✕	Measuring range		Jaw length		Reading		Error limit	Depth gauge	Order no.	List price
	mm	inch	mm	inch	mm	inch				
✕	With DATA VARIABLE, with extra long cross points (40 mm)									
▪	0 - 150	0 - 6	40	1.6	0.01	.0005	0.03	round 1.5	1320 518	395.00



1998720



1998501



1997501

Accessories

- Battery, 3V-Lithium, CR 2032
- Data cable DATA VARIABLE to digimatic
- Data cable DATA VARIABLE to RS232
- Data cable DATA VARIABLE to USB

Order no.

- 0220 704
- 1998 501
- 1997 501
- 1998 720

List price

EUR

- 3.90
- 64.00
- 50.00
- 72.00



HELIOS · PREISSER

0262 Caliper for external locking grooves

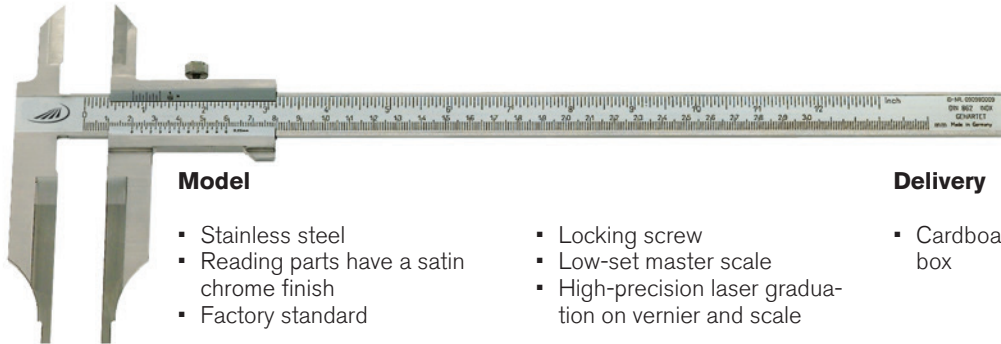

Model

- Stainless steel
- Reading parts have a satin chrome finish
- Factory standard
- Locking screw
- Low-set master scale
- High-precision laser graduation on vernier and scale

Delivery

- Cardboard box

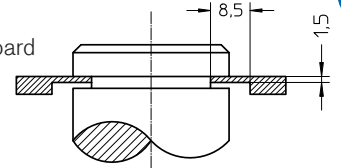

✕	Measuring range		Jaw length		Reading		Error limit	Order no.	List price
	mm	inch	mm	inch	mm	inch			
	0 - 300	0 - 12	90	3.5	0.05	1/128	0.03	0262 503	EUR 271.00

1353 DIGI-MET® Caliper for external locking grooves

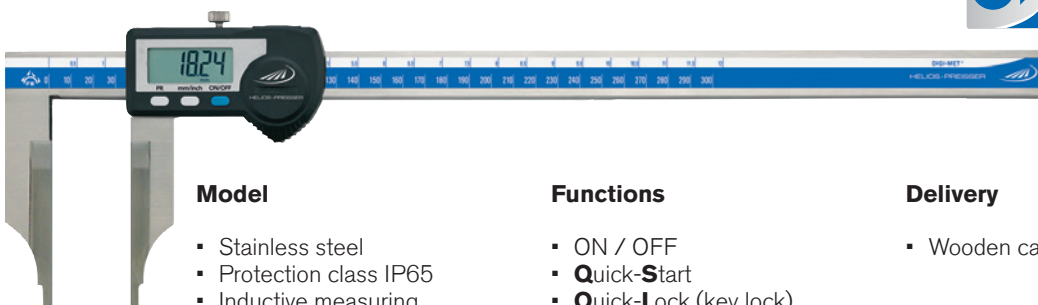

Model

- Stainless steel
- Protection class IP65
- Inductive measuring system
- LCD display 10 mm
- Locking screw
- Factory standard

Functions

- ON / OFF
- Quick-Start
- Quick-Lock (key lock)
- Set to zero at any point
- mm / inch switching
- PRESET-Function (setting a numerical value)
- Variable data output RS 232 + Digimatic + USB

Delivery

- Wooden case

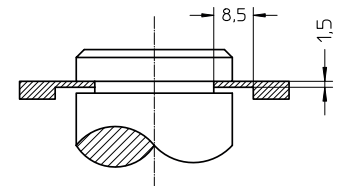

✕	Measuring range		Jaw length		Reading		Error limit	Order no.	List price
	mm	inch	mm	inch	mm	inch			
	0 - 300	0 - 12	90	3.5	0.01	.0005	0.03	1353 522	EUR 491.00



1998720 1997501 1998501

Accessories

	Order no.	List price
Battery, 3V-Lithium, CR 2032	0220 704	EUR 3.90
Data cable DATA VARIABLE to RS232	1997 501	50.00
Data cable DATA VARIABLE to digimatic	1998 501	64.00
Data cable DATA VARIABLE to USB	1998 720	72.00



HELIOS · PREISSER

1352 DIGI-MET® Calipers for internal grooves



Model

- Stainless steel
- LCD display 7.5 mm
- Factory standard
- Locking screw
- Protection class IP65

Functions

- ON / OFF
- **Quick-Start**
- **Quick-Lock** (key lock)
- Set to zero at any point
- mm / inch switching
- PRESET-Function (setting a numerical value)

- Variable data output RS 232 + Digimatic + USB

Delivery

- Wooden case

Measuring range	Jaw length		Reading		Error limit	Order no.	List price
	mm	mm	inch	mm			
10 - 160	25	1.0	0.01	.0005	0.06	1352 516	388.00
20 - 160	40	1.5	0.01	.0005	0.06	1352 517	437.00
26 - 200	60	2.3	0.01	.0005	0.06	1352 518	800.00
30 - 250	80	3.1	0.01	.0005	0.06	1352 520	900.00
35 - 300	100	3.9	0.01	.0005	0.06	1352 522	939.00

0258 Calipers for internal grooves

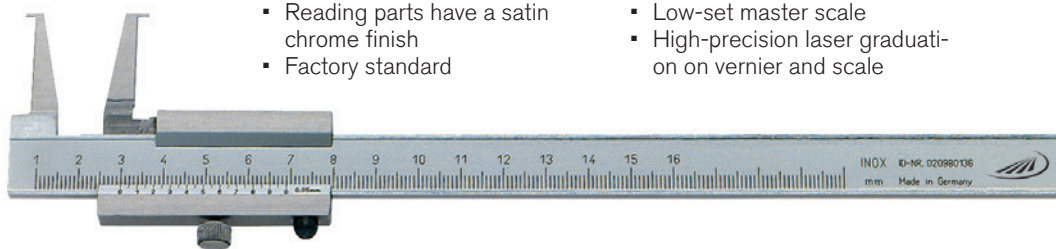

Model

- Stainless steel
- Reading parts have a satin chrome finish
- Factory standard

Delivery

- Cardboard box

Measuring range	Jaw length		Reading	Error limit	Order no.	List price
	mm	mm				
10 - 160	25	1.0	0.05	0.1	0258 501	144.00
20 - 160	40	1.5	0.05	0.1	0258 502	192.00
26 - 200	60	2.3	0.05	0.1	0258 503	295.00
30 - 250	80	3.1	0.05	0.1	0258 504	333.00
35 - 300	100	3.9	0.05	0.1	0258 505	372.00

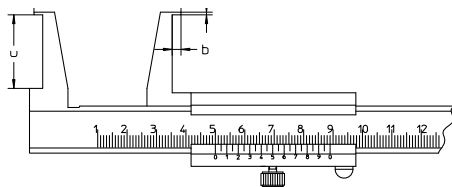

Measuring range mm	a	b	c
10 - 160	0.9	3.0	25
20 - 160	2.0	5.0	40
26 - 200	3.0	7.0	60
30 - 250	4.0	8.5	80
35 - 300	5.0	10.0	100