

RELATIVE PRODUCT: DISK BRAKE MICROMETER (CODE 3288-, 3588-)

DATA OUTPUT

DIGITAL DISK BRAKE AND PAD CALIPERS (NON-WATERPROOF)

- Measure thickness of disk brakes and pad wear
- Resolution: 0.01mm/0.0005"
- Buttons: on/off, zero, mm/inch
- Automatic power off, move the digital unit to turn on power
- Battery CR2032
- Data output
- Made of stainless steel
- Optional accessory: data output cable (code 7315-, 7302-, 7305-, for calipers without built-in wireless)



1167-150A

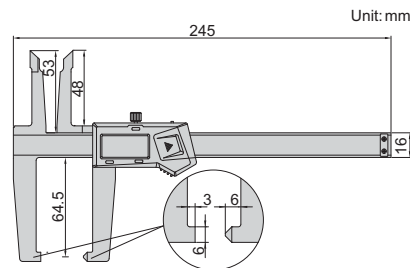
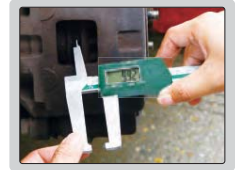

Code	Range	Accuracy	Wireless
1167-150A	0-150mm/0-6"	±0.07mm	no
1167-150AWL			built-in wireless

RELATIVE PRODUCT: DISK BRAKE MICROMETER (CODE 3288-, 3588-)

DATA OUTPUT

DIGITAL DRUM BRAKE CALIPERS (NON-WATERPROOF)

- Measure internal and external diameter of drum brakes
- Resolution 0.01mm/0.0005"
- Buttons: on/off, zero, mm/inch
- Automatic power off, move the digital unit to turn on power
- Battery CR2032
- Data output
- Made of stainless steel
- Optional accessory: data output cable (code 7315-, 7302-, 7305-, for calipers without built-in wireless)



1168-300A

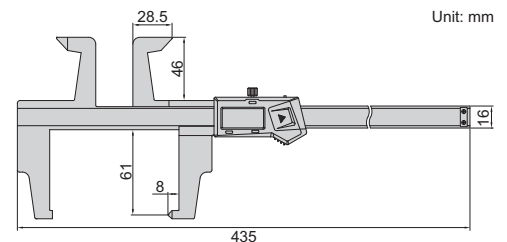

Code	Range	Accuracy	Wireless
1168-300A	0-300mm/0-12"	±0.07mm	no
1168-300AWL			built-in wireless

IP67 WATERPROOF

ATTENTION: NO DATA OUTPUT

ATTENTION: IT IS NECESSARY TO SET ZERO AFTER POWER ON EACH TIME

WATERPROOF DIGITAL DEPTH GAGES

- IP67 dust/waterproof
- Resolution: 0.01mm/0.0005"
- Button function: zero, on/off, mm/inch, ABS/REL, hold
- Meet DIN862
- Battery CR2032
- Made of stainless steel

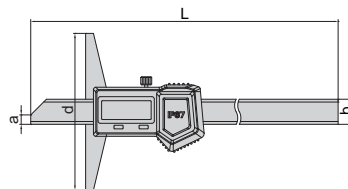

1149-150

Code	Range	Accuracy	L	a	b	d
1149-150	0-150mm/0-6"	±0.03mm	240	6	16	100
1149-200	0-200mm/0-8"	±0.03mm	290	6	16	100
1149-300	0-300mm/0-12"	±0.03mm	390	6	16	150

DIGITAL DEPTH GAGES (STANDARD TYPE, NON-WATERPROOF)

DATA OUTPUT

- Buttons: on/off, zero, mm/inch (except metric type)
- Automatic power off, move the digital unit to turn on power
- Meet DIN862 (except 0-500mm/0-20", 0-1000mm/0-40")
- Battery CR2032, data output
- Made of stainless steel
- Optional accessory: data output cable (code **7315-**, **7302-**, **7305-**, for depth gages without built-in wireless)



1141-150A

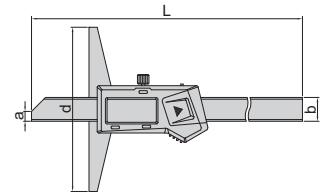

Metric/Inch type

Code	Range	Resolution	Accuracy	L	a	b	d	Wireless
1141-150A	0-150mm/0-6"	0.01mm/0.0005"	±0.03mm	230mm	6mm	14.5mm	100mm	no
1141-150AWL								built-in wireless
1141-200A	0-200mm/0-8"	0.01mm/0.0005"	±0.03mm	280mm	6mm	14.5mm	100mm	no
1141-200AWL								built-in wireless
1141-300A	0-300mm/0-12"	0.01mm/0.0005"	±0.03mm	380mm	6mm	14.5mm	150mm	no
1141-300AWL								built-in wireless
1141-500A	0-500mm/0-20"	0.01mm/0.0005"	±0.05mm	585mm	7mm	15mm	150mm	no
1141-500AWL								built-in wireless
1141-1000A	0-1000mm/0-40"	0.01mm/0.0005"	±0.07mm	1188mm	7mm	18mm	150mm	no
1141-10001A	0-1000mm/0-40"	0.01mm/0.0005"	±0.07mm	1188mm	7mm	18mm	200mm	no
1141-10002A	0-1000mm/0-40"	0.01mm/0.0005"	±0.07mm	1188mm	7mm	18mm	250mm	no
1141-10003A	0-1000mm/0-40"	0.01mm/0.0005"	±0.07mm	1188mm	7mm	18mm	300mm	no

Metric type

Code	Range	Resolution	Accuracy	L	a	b	d
1141-150AJ	0-150mm	0.01mm	±0.03mm	230mm	6mm	14.5mm	100mm
1141-200AJ	0-200mm	0.01mm	±0.03mm	280mm	6mm	14.5mm	100mm
1141-300AJ	0-300mm	0.01mm	±0.03mm	380mm	6mm	14.5mm	150mm
1141-500AJ	0-500mm	0.01mm	±0.05mm	585mm	7mm	15mm	150mm

DIGITAL HOOK DEPTH GAGES (NON-WATERPROOF)

DATA OUTPUT

- Resolution: 0.01mm/0.0005"
- Buttons: on/off, zero, mm/inch
- Automatic power off, move the digital unit to turn on power
- Battery CR2032, data output
- Made of stainless steel
- Optional accessory: data output cable (code **7315-**, **7302-**, **7305-**, for depth gages without built-in wireless)



1142-150A

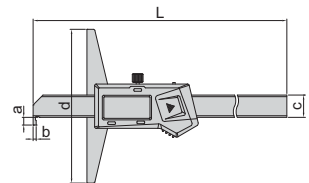

Code	Range	Accuracy	L	d	a	b	c	Wireless
1142-150A	0-150mm/0-6"	±0.03mm	230mm	100mm	5mm	2mm	14.5mm	no
1142-150AWL								built-in wireless
1142-200A	0-200mm/0-8"	±0.03mm	280mm	100mm	5mm	2mm	14.5mm	no
1142-200AWL								built-in wireless
1142-300A	0-300mm/0-12"	±0.04mm	380mm	150mm	5mm	2mm	14.5mm	no
1142-300AWL								built-in wireless
1142-500A	0-500mm/0-20"	±0.05mm	585mm	150mm	8mm	3mm	15mm	no
1142-500AWL								built-in wireless
1142-5001A	0-500mm/0-20"	±0.05mm	585mm	200mm	8mm	3mm	15mm	no
1142-5001AWL	0-500mm/0-20"	±0.05mm	585mm	200mm	8mm	3mm	15mm	built-in wireless
1142-1000A	0-1000mm/0-40"	±0.07mm	1188mm	150mm	10mm	4mm	18mm	no
1142-10001A	0-1000mm/0-40"	±0.07mm	1188mm	200mm	10mm	4mm	18mm	no
1142-10002A	0-1000mm/0-40"	±0.07mm	1188mm	250mm	10mm	4mm	18mm	no

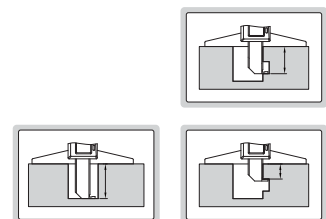

DIGITAL DOUBLE HOOK DEPTH GAGES (NON-WATERPROOF)

- Resolution: 0.01mm/0.0005"
- Buttons: on/off, zero, mm/inch
- Automatic power off, move the digital unit to turn on power
- Meet DIN862
- Battery CR2032, data output
- Made of stainless steel
- Optional accessory: data output cable (code 7315-, 7302-, 7305-, for depth gages without built-in wireless)



1144-150A (mm)

DATA OUTPUT

3

Code	Range	Accuracy	L	d	a	b	c	e	Wireless
1144-150A	0-150mm/0-6"	±0.03mm	233	100	21.5	3.5	14.5	2.5	no
1144-150AWL									built-in wireless
1144-200A	0-200mm/0-8"	±0.03mm	283	100	21.5	3.5	14.5	2.5	no
1144-200AWL									built-in wireless
1144-300A	0-300mm/0-12"	±0.03mm	383	150	21.5	3.5	14.5	2.5	no
1144-300AWL									built-in wireless
1144-500A	0-500mm/0-20"	±0.05mm	585	150	25	5	15	3	no
1144-500AWL									built-in wireless
1144-5001A	0-500mm/0-20"	±0.05mm	585	200	25	5	15	3	no
1144-5001AWL									built-in wireless
1144-1000A	0-1000mm/0-40"	±0.07mm	1188	150	32	7	18	4	no
1144-10001A									built-in wireless
1144-10002A	0-1000mm/0-40"	±0.07mm	1188	250	32	7	18	4	no

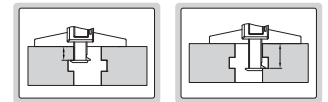
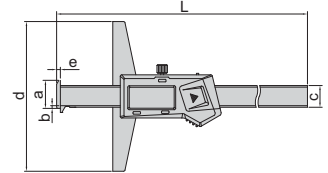

DIGITAL DEPTH GAGES WITH MOUNTING HOLES FOR EXTENSION BASE (NON-WATERPROOF)

- Resolution: 0.01mm/0.0005"
- Buttons: on/off, zero, mm/inch
- Automatic power off, move the digital unit to turn on power
- Meet DIN862
- Battery CR2032, data output
- Made of stainless steel
- Optional accessory: data output cable (code 7315-, 7302-, 7305-, for depth gages without built-in wireless), extension base (code 6141)



1147-300

DATA OUTPUT

Code	Range	Accuracy	L	Wireless
1147-150	0-150mm/0-6"	±0.03mm	237mm	no
1147-150WL				built-in wireless
1147-200	0-200mm/0-8"	±0.03mm	287mm	no
1147-200WL				built-in wireless
1147-300	0-300mm/0-12"	±0.03mm	403mm	no
1147-300WL				built-in wireless
1147-500	0-500mm/0-20"	±0.05mm	605mm	no
1147-500WL				built-in wireless

extension base (optional)

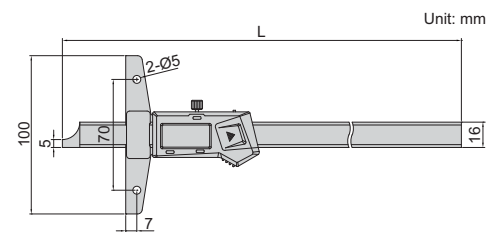

DIGITAL POINT DEPTH GAGES (NON-WATERPROOF)

- Resolution: 0.01mm/0.0005"
- Buttons: on/off, zero, mm/inch
- Automatic power off, move the digital unit to turn on power
- Meet DIN862
- Battery CR2032
- Data output
- Made of stainless steel
- Optional accessory: data output cable (code 7315-, 7302-, 7305-, for depth gages without built-in wireless)



1143-200A

DATA OUTPUT

Code	Range	Accuracy	Wireless
1143-200A	0-200mm/0-8"	±0.03mm	no
1143-200AWL			built-in wireless

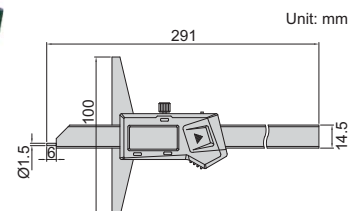
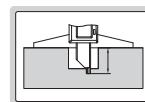

DIGITAL DEPTH GAGES WITH ROUND DEPTH BAR (NON-WATERPROOF)

MEASURE WIDTH AND DEPTH OF GROOVES INSIDE BORE

MEASURE DEPTH OF SMALL HOLES (>Ø4mm)

DATA OUTPUT

3

- Resolution: 0.01mm/0.0005"
- Supplied with three interchangeable points (flat, spherical, disk)
- Buttons: on/off, set, mm/inch, preset (+, -)
- Automatic power off, move the digital unit to turn on power
- Battery CR2032
- Data output
- Made of stainless steel
- Optional accessory: data output cable (code 7315-, 7302-, 7305-, for depth gages without built-in wireless), extension base (code 6141, for 1148-120, 1148-120WL, 1148-200, 1148-200WL, 1148-300 and 1148-300WL)

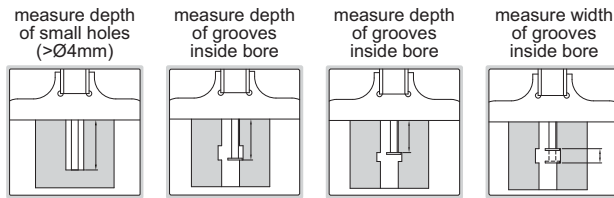
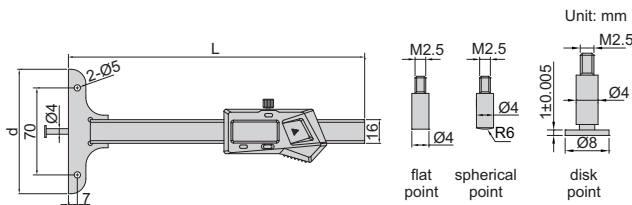

1148-100S



1148-120

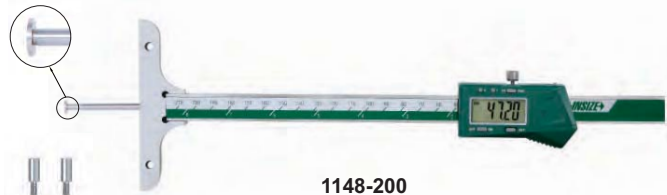

1148-200

Code	Range *	Accuracy	L	d	Remark
1148-100S	0-100mm/0-4"	±0.02mm	200	45	no
1148-100SWL					built-in wireless
1148-100	0-100mm/0-4"	±0.02mm	200	85	no
1148-100WL					built-in wireless
1148-120	0-120mm/0-4.7"	±0.03mm	300	101	one-hand use, with mounting holes for extension base
1148-120WL					one-hand use, with mounting holes for extension base, built-in wireless
1148-200	0-200mm/0-8"	±0.03mm	300	101	with mounting holes for extension base
1148-200WL					with mounting holes for extension base, built-in wireless
1148-300	0-300mm/0-12"	±0.04mm	400	101	with mounting holes for extension base
1148-300WL					with mounting holes for extension base, built-in wireless

*When disk points are used, the range is reduced by 10mm

OPTIONAL DISK POINTS

Code	Description	H	Remark
1148-P101	0.5mm disk point	0.5±0.005mm	for narrow grooves
1148-P102	0.7mm disk point	0.7±0.005mm	for narrow grooves
1148-P103	1mm disk point	1±0.005mm	for grooves inside blind hole
1148-P104	0.5mm disk point	0.5±0.005mm	for grooves inside blind hole

1148-P101 (optional)

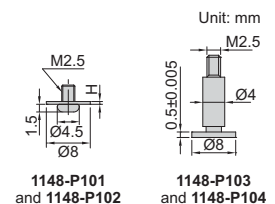

1148-P101 and 1148-P102

1148-P103 and 1148-P104

one-hand use of 1148-120 and 1148-120WL



extension base for 1148-120, 1148-120WL, 1148-200, 1148-200WL, 1148-300 and 1148-300WL (optional)



1148-P103 (optional), measure width of bottom grooves inside blind hole

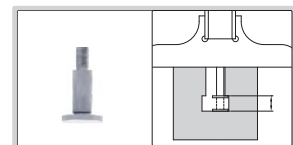

VERNIER DEPTH GAGE (ECONOMIC TYPE)

- Graduation: 0.1mm
- Made of stainless steel

Code	Range	Accuracy
1244-30	0-30mm	±0.10mm



1244-30

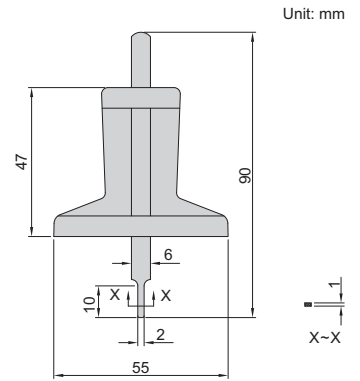

Unit: mm

DATA OUTPUT

MINI DIGITAL DEPTH GAGES WITH ROUND BAR (NON-WATERPROOF)

- Measure depth of small groove and hole
- Resolution: 0.01mm/0.0005"
- Buttons: on/off, set, mm/inch, preset (+,-)
- Automatic power off, move the digital unit to turn on power
- Battery CR2032
- Data output
- Made of stainless steel
- Optional accessory: data output cable (code 7315-, 7302-, 7305-, for depth gages without built-in wireless)



1140-25

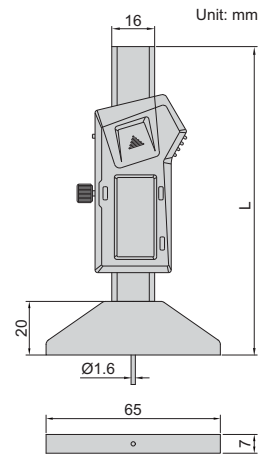

Unit: mm

Code	Range	Accuracy	L	Wireless
1140-25	0-25mm/0-1"	±0.02mm	114mm	no
1140-25WL				built-in wireless
1140-50	0-50mm/0-2"	±0.02mm	140mm	no
1140-50WL				built-in wireless

DATA OUTPUT

MINI DIGITAL DEPTH GAGES (NON-WATERPROOF)

- Measure depth of small groove and hole, also measure depth of tire tread
- Resolution: 0.01mm/0.0005"
- Buttons: on/off, zero, mm/inch
- Supplied with zero set surface
- Automatic power off, move the digital unit to turn on power
- Battery CR2032
- Data output
- Made of stainless steel
- Optional accessory: data output cable (code 7315-, 7302-, 7305-, for depth gages without built-in wireless)



1145-25A

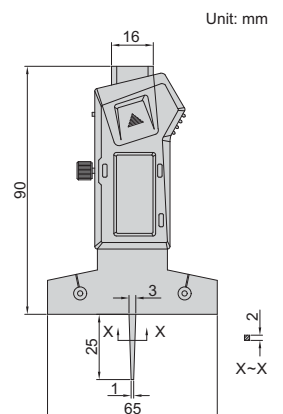

Unit: mm

Code	Range	Accuracy	Wireless
1145-25A	0-25mm/0-1"	±0.03mm	no
1145-25AWL			built-in wireless